

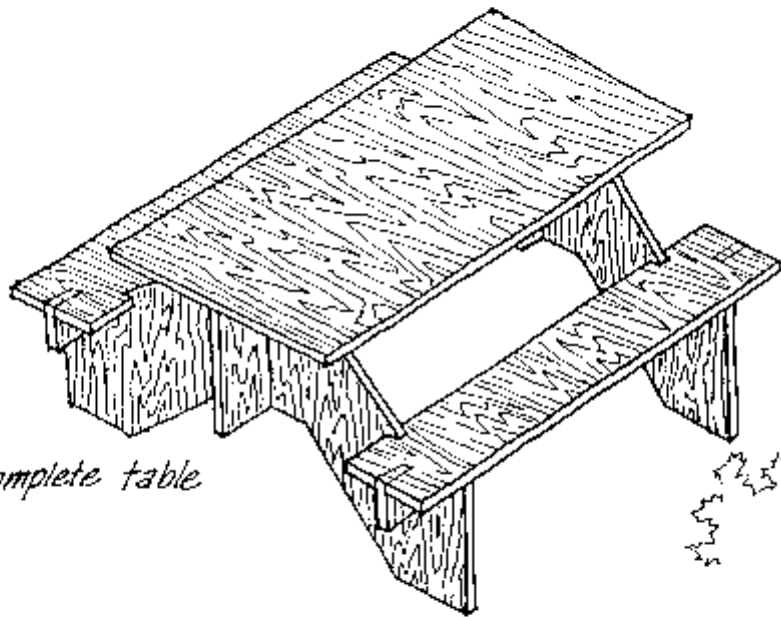

THE PATROL SKETCHBOOK



№ 3 CAMP TABLE



Complete table

This simple plywood table is a most serviceable item for a variety of camp needs. When used together with a Patrol Kitchen Box (Patrol Sketchbook № 2) there is hardly a better, more portable, setup for cooking and dining.

Easily transported, assembled and disassembled, this table can be a most welcomed addition to a Patrol's camping gear!



MATERIALS LIST

- 1- sheet 3/4" x 4'-0" x 8'-0" exterior fir plywood
- 8- #8 x 1 1/4" flathead wood screws
- 4- safety gate hooks and eyes
- paint, varnish, stain

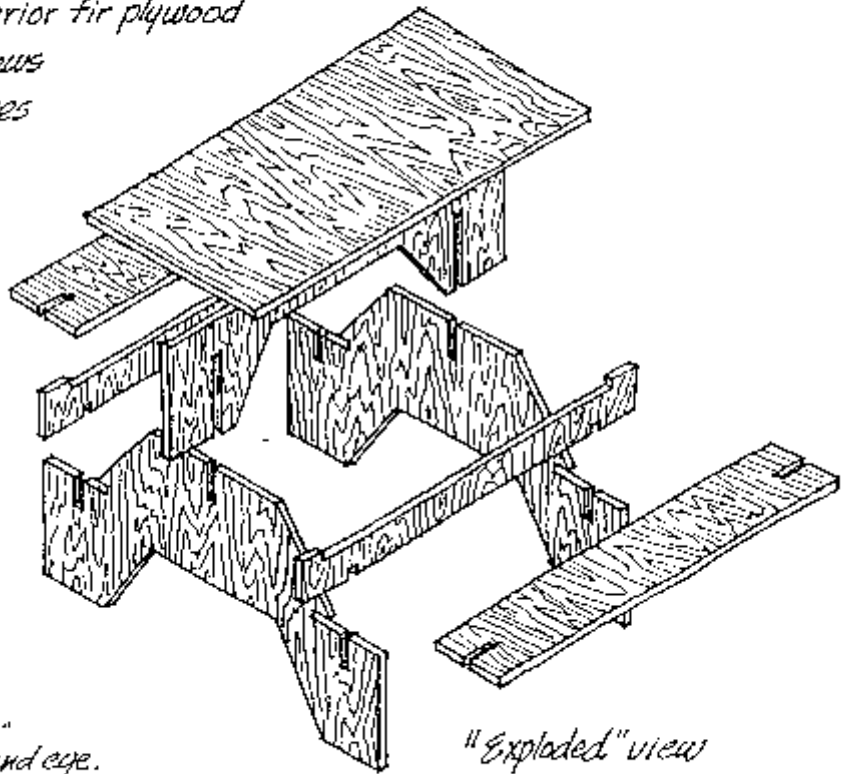

"Exploded" view

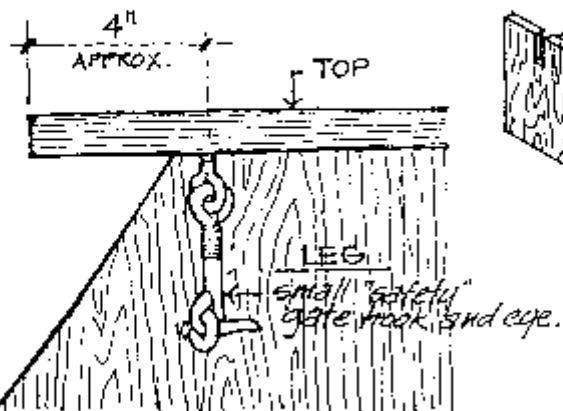

Fastening Top to Legs Detail

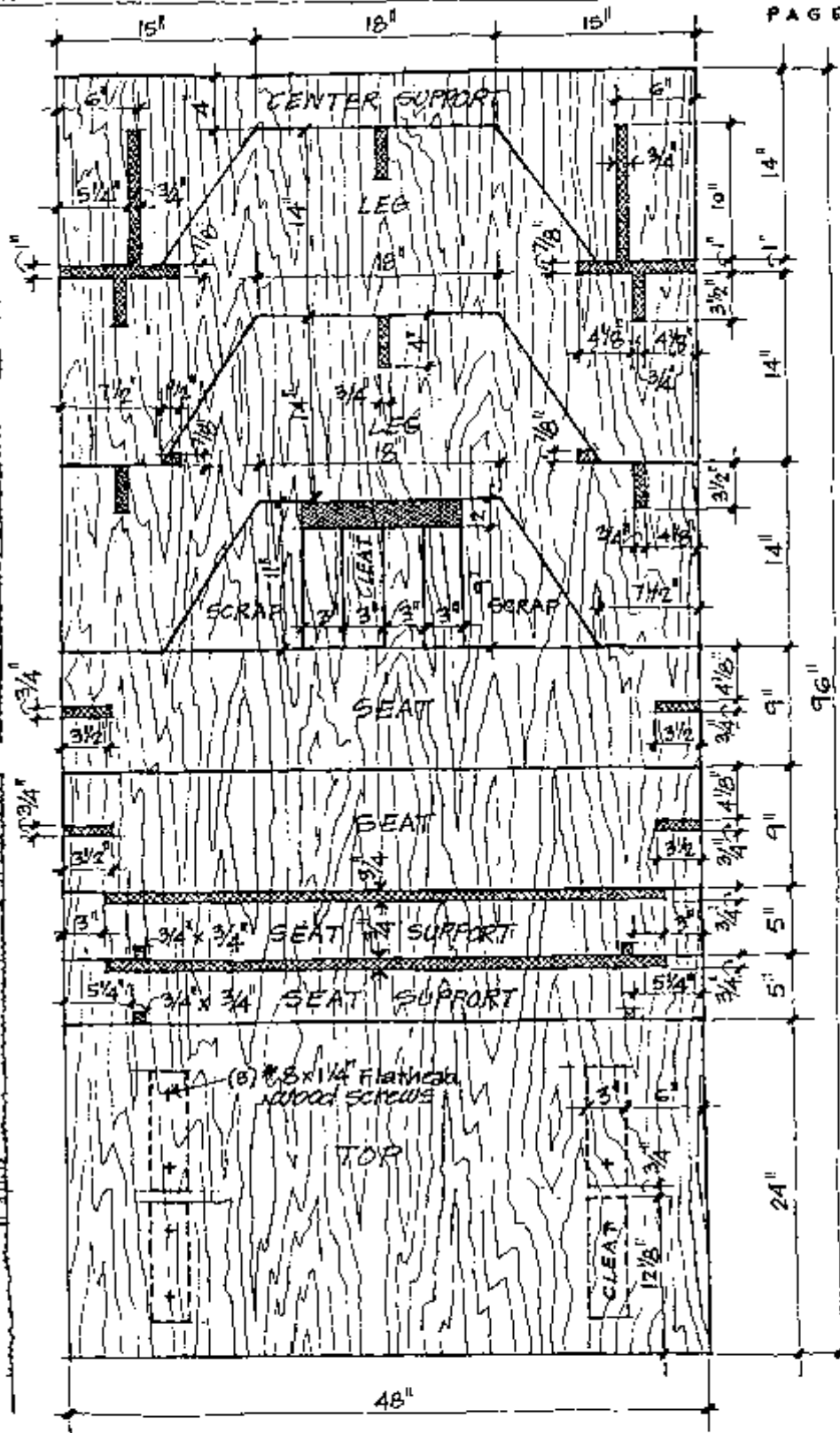
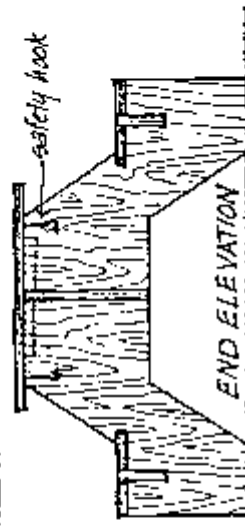

Start cutting out pieces starting with the table top then working towards the center support. Lay out each piece as you go and not all at once - each saw cut (depending on blade) will remove approximately 1/8" of useable material, thereby shortening your plywood as you make each cut. A sharp plywood blade is recommended.

indicates scrap pieces

- NOTES:
1. Use 3/4" thick exterior grade plywood.
 2. Fasten cleats to underside of top with #8 x 1 1/4" long flathead screws.
 3. Cut carefully to insure a good fit.
 4. Sand all edges free of splinters or roughness.
 5. Finish with stain & varnish or paint with exterior enamel.



№2 PATROL KITCHEN BOX

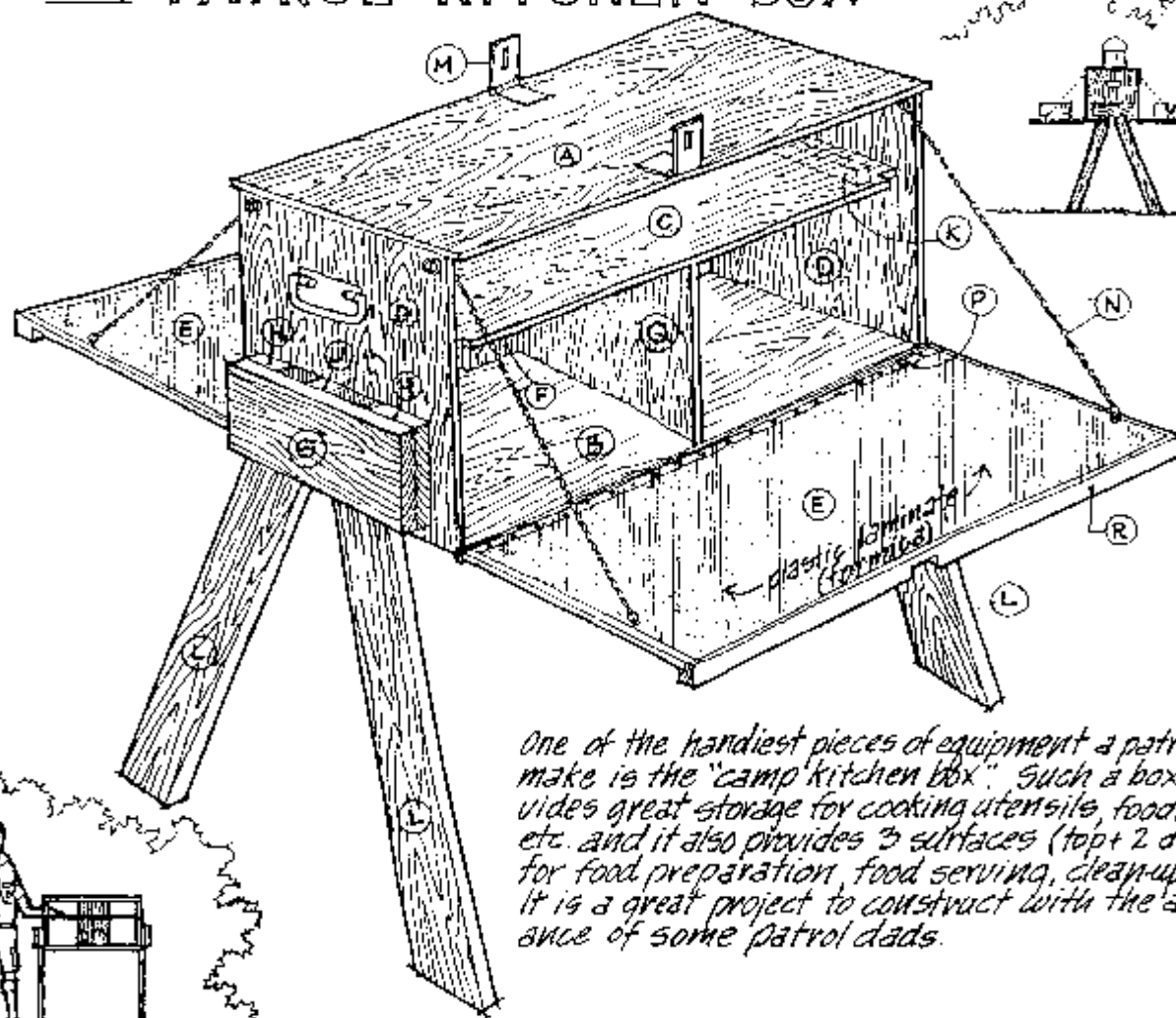

One of the handiest pieces of equipment a patrol can make is the "camp kitchen box". Such a box provides great storage for cooking utensils, food, spices, etc. and it also provides 3 surfaces (top & 2 doors) for food preparation, food serving, clean-up, etc. It is a great project to construct with the assistance of some patrol dads.

MATERIALS LIST

- | | |
|---|--|
| A - 1 Top: 16" x 32" x 3/8" A/C Plywood | P - 2 Continuous Hinge - 1 1/16" x 30" w/ screws |
| B - 1 Bottom: 15 1/4" x 31 1/4" x 3/8" A/C Plywood | Q - 1 Divider Panel: 9 5/8" x 15 1/4" x 3/8" Plywood |
| C - 1 Shelf: 15 1/4" x 31 1/4" x 3/8" A/C Plywood | R - 2 Door Stiffeners: 3/4" x 3/4" x 32" y. pine |
| D - 2 Ends: 15 1/4" x 15 5/8" x 3/8" A/C Plywood | 50 - CS wood screws #6 - 1 1/4" long |
| E - 2 Doors: 15 1/4" x 32" x 3/8" A/C Plywood | 20 - CS wood screws #4 - 1" long |
| F - 1 Center Brace: 10" x 15 5/8" x 3/8" Plywood | 40 - Ad finish nails or brads |
| G - 2 End Plates: 5" x 15" x 3/4" pine | 2 - handles, metal or rope. |
| H - 4 Filler Blocks: 5" x 5" x 3/4" yellow pine | N - 4 sash chains - 24" long - cut to length |
| J - 2 Filler Blocks: 3" x 5" x 3/4" yellow pine | — 2 pieces - 32" x 15" plastic laminate (Formica) |
| K - 2 Shelf supports: 3/4" x 3/4" x 14" yellow pine | Carpenter's glue |
| L - 4 Legs: 3 1/2" x 36" yellow pine | Paint or varnish. (Remember lighter colors reflect heat better than dark finishes) |
| M - 2 Hasps | |

Note: All plywood panels are 3/8" thick.

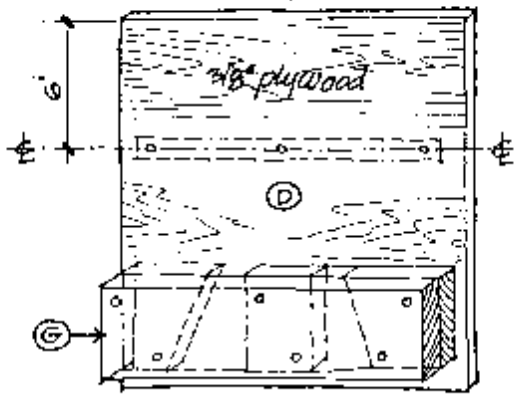
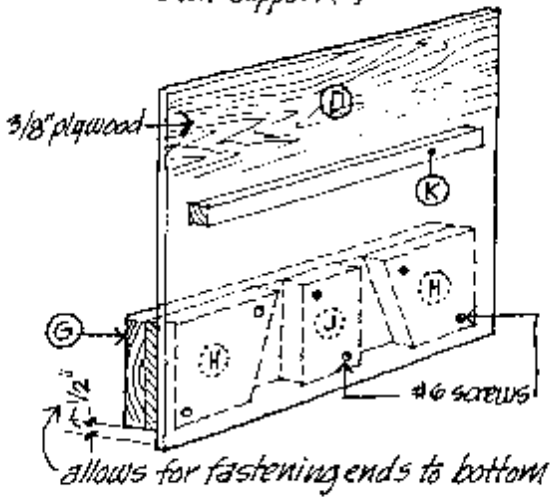
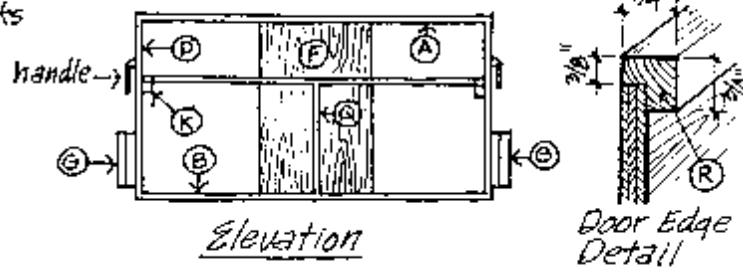
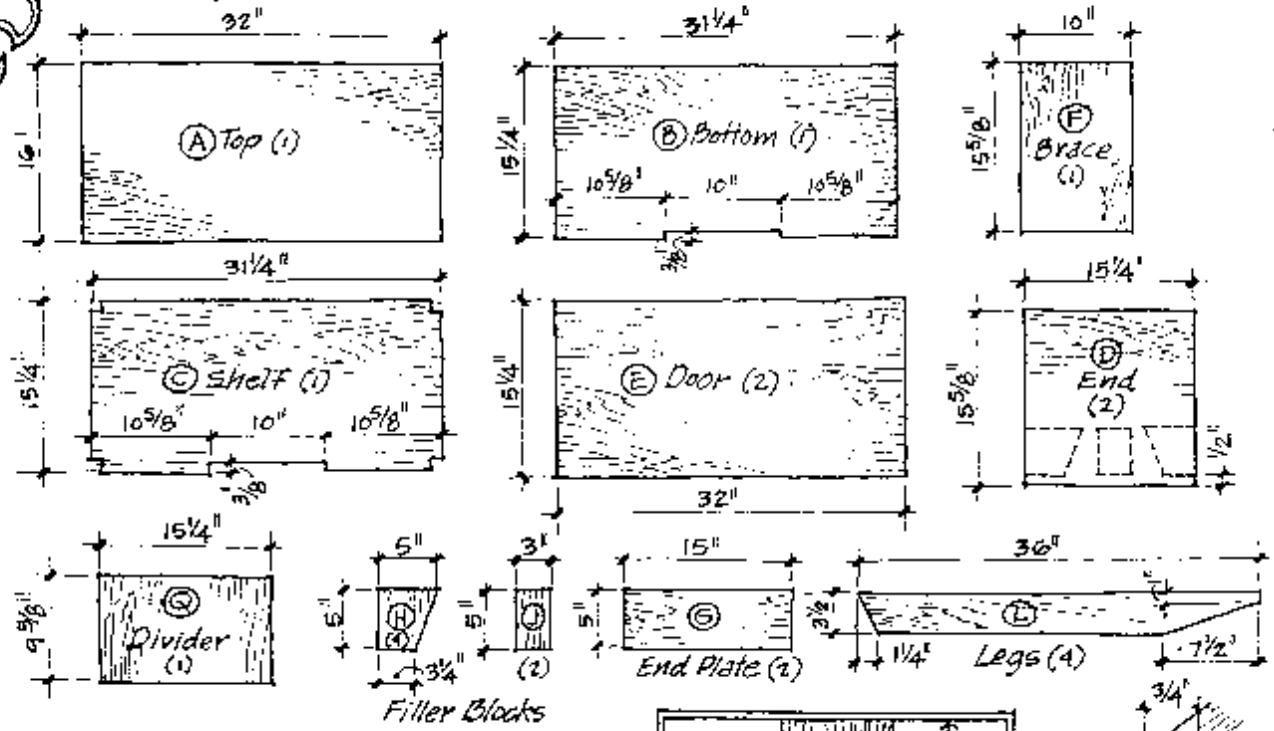

ASSEMBLY

- Fasten pieces G, H, J, & K to end panels D with glue, nails, & screws as shown.
- After ends are assembled, fasten Bottom B to end sections, then divider panel Q, next the shelf C and finally the top panel A. Attach with glue, nails and screws (1/4" screws in top and bottom and 1" screws in shelf).
- Square up box and attach the brace panel F to bottom panel B, shelf C, and top A.
- Attach with glue and nails the door edge stiffener R to the door panels E.
- Apply laminate plastic to inside door surface with non-flammable contact cement. *
- Fasten hinges to inside face of door then attach to box.
- Attach hasps, handles, and sash chains
- Paint or varnish as desired.
- Enjoy!
- * Plastic laminate is an option but well worth the effort (easy to clean, durable, etc.)



The PATROL SKETCHBOOK

By IGHKOTEKAY
©1992

NO. 1 PATROL FLAGS:

Every Boy Scout patrol should have its own custom designed and custom made patrol flag. Such a flag should speak well of the patrol and be an object of pride for each patrol member. It should be attractive and easy to carry; it should also withstand rain, sun, snow and wind. The patrol flag goes with the patrol on all outings - its their calling card and recognition sign! Below and on the next page are some ideas to get a patrol started. Have fun!

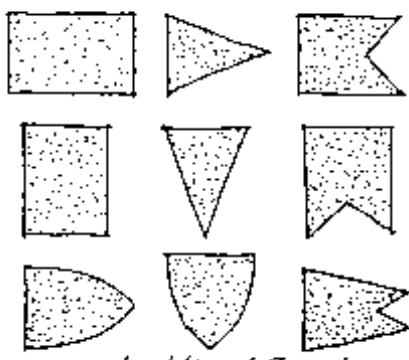

some traditional flag shapes

FLAG "STEPS"

1. Have a patrol "Art Contest." Everyone submits an idea. Choose the best ideas and form a final design.
2. Make a full size drawing on a large piece of paper.
3. Work out details of construction.
4. Make flag (get some help from a patrol Mom if needed)
5. Attach to flag staff and attach honor ribbons, etc.

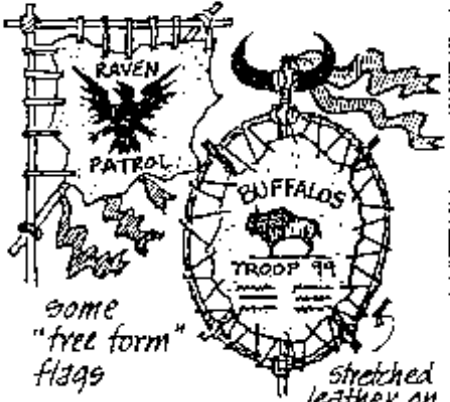

stretched leather on wood "hoop"

MATERIALS

- cloth, leather, rawhide, fur, canvas, plastic, metal - whatever works best but remember to make it strong but not too heavy. Avoid materials that might shrink, fade, or run from rain and sun.
- Quilt edging tape works well when hemming/edging cloth flags.
- A cut staff from the woods works well (sassafras is strong but light weight) and wooden closet rods from the lumber yard work great.

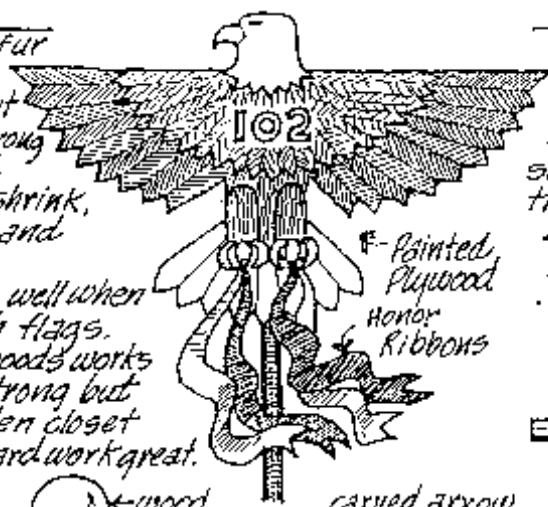

SIZE

- There is certainly no "official" size so that is up to the patrol.
- Remember to keep it of such a size and shape for the flag to be easily carried.
- A recommended size is in the 1 1/2 foot x 2 foot range.
- Make flag staff about 6 foot long (approx 1" diameter)

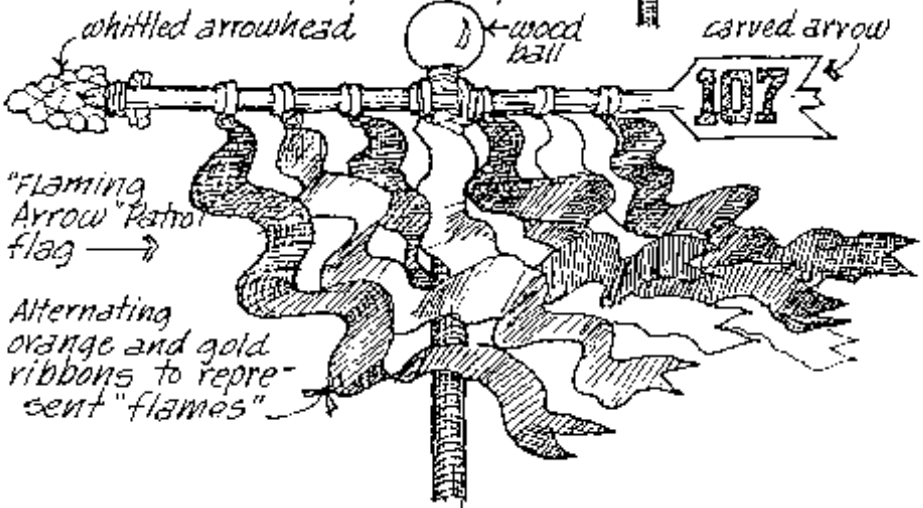

"Flaming Arrow" Patrol flag

Alternating orange and gold ribbons to represent "flames"

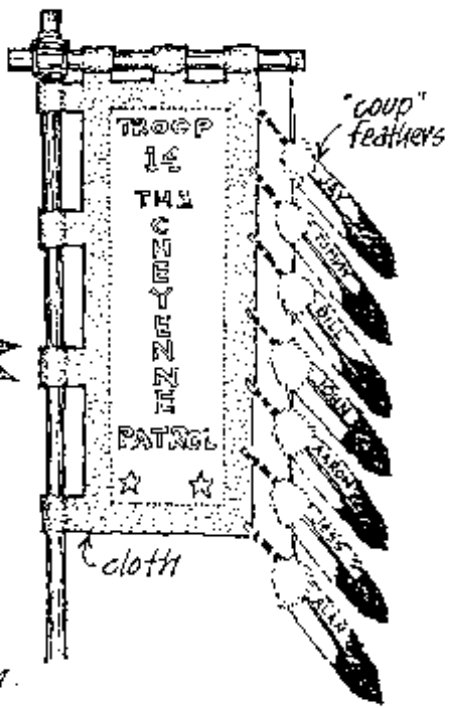

cloth

Remember "flags" can be of many different shapes, sizes, materials and so forth, so use your imagination.

PATROL FLAGS (continued)

"ART" TIPS

- Patrol symbol or "totem" can be enlarged from a small drawing or photo to the desired size by many copying (xerox) machines.
- Another way to enlarge a drawing or photo is drawing a grid of lines over the subject matter then drawing a larger grid of the same number on a piece of paper, then fill in the squares on the larger version where they appear proportionately on the smaller grid.

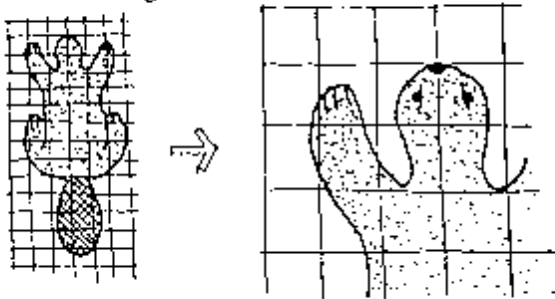

Grid method of enlarging

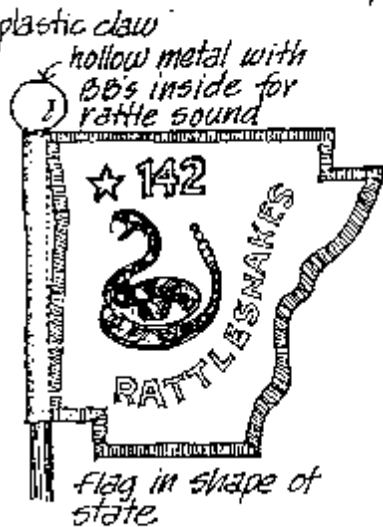
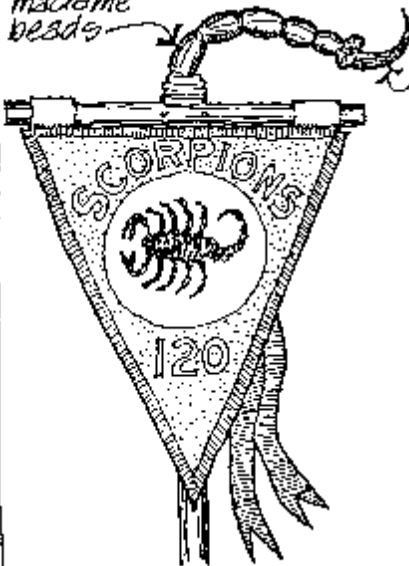

Flag in shape of state

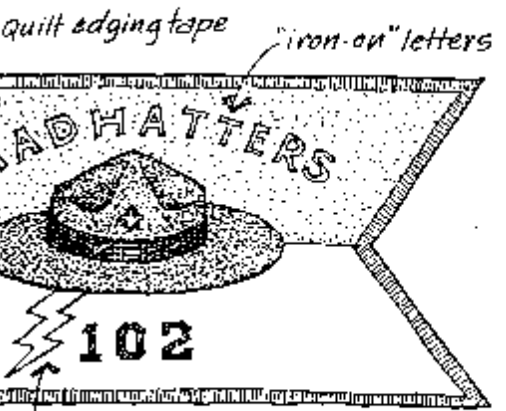

Emblem was cut from fabric and attached (on both sides of flag) with iron-on backing (from fabric store)

- Transfer final drawing to flag surface or "iron-on" with carbon paper.
- Avoid felt tip markers on fabric because they blot and fade too easily.
- Acrylic paints are easy to use and work great on cloth, leather or wood. Acrylics can be found at art supply stores.

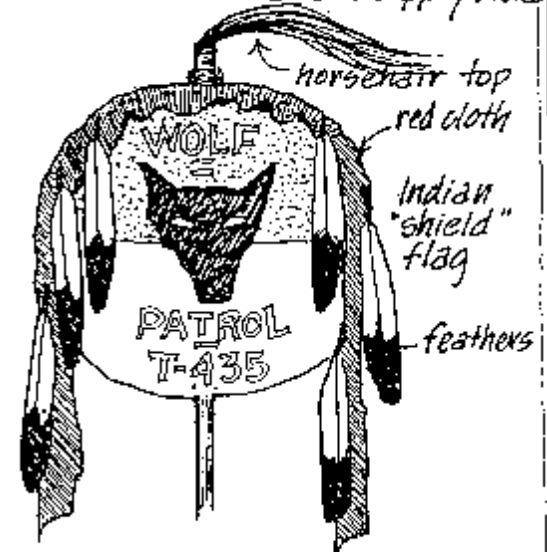

DECORATIVE SUGGESTIONS

- Patrol name written in letters may not always be necessary - totem may say it.
- Include troop number always
- Add honor awards as they are earned.
- Include patrol members names in some manner on flag or staff.
- Carve a notch in the staff for every overnight camp and every 5 miles hiked.
- On "traditional" cloth flags apply art work on both sides of flag.

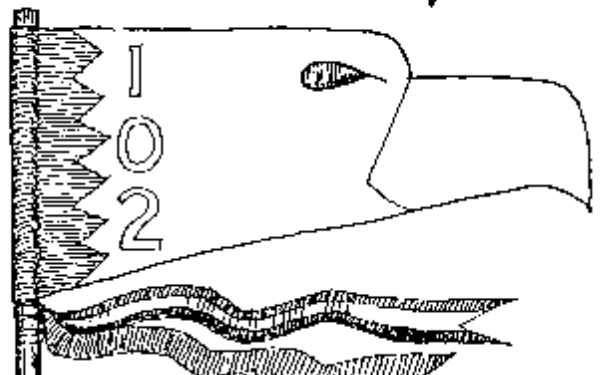



The PATROL SKETCHBOOK

By III
ISHKOTEKAY
1992

"SCOUT STAVE" OR HIKING STICK

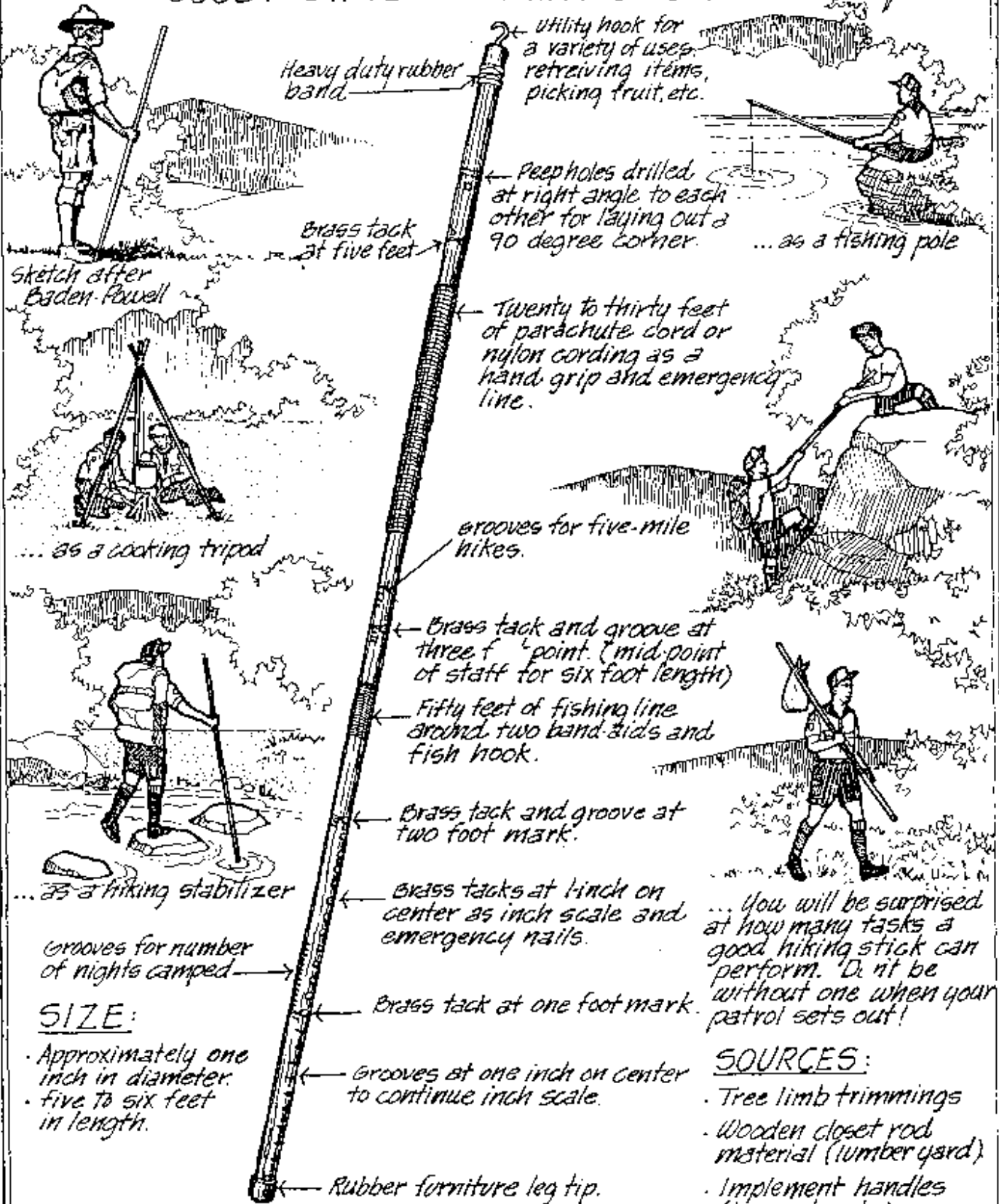

Sketch after Baden-Powell

... as a cooking tripod

... as a hiking stabilizer

... as a fishing pole

... You will be surprised at how many tasks a good hiking stick can perform. Don't be without one when your patrol sets out!

Grooves for number of nights camped

SIZE:

- Approximately one inch in diameter.
- Five to six feet in length.

Utility hook for a variety of uses, retrieving items, picking fruit, etc.

Heavy duty rubber band

Brass tack at five feet

Peepholes drilled at right angle to each other for laying out a 90 degree corner.

Twenty to thirty feet of parachute cord or nylon cording as a hand grip and emergency line.

grooves for five-mile hikes.

Brass tack and groove at three foot point. (mid-point of staff for six foot length)

Fifty feet of fishing line around two bands and fish hook.

Brass tack and groove at two foot mark.

Brass tacks at hinch on center as inch scale and emergency nails.

Brass tack at one foot mark.

Grooves at one inch on center to continue inch scale.

Rubber furniture leg tip.

SOURCES:

- Tree limb trimmings
- Wooden closet rod material (lumber yard)
- Implement handles (hoe, rake, etc.).